

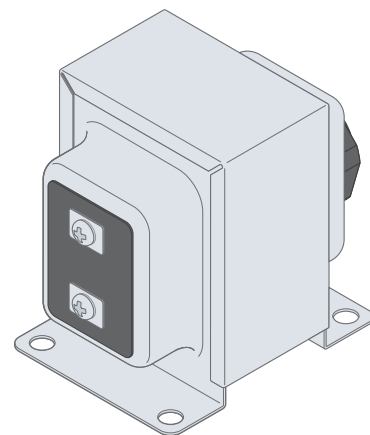

Hardwired Transformer Kit



Welcome

This kit contains the transformer we recommend for powering a Ring Video Doorbell Pro along with a 16-24 volt AC doorbell chime (required). This transformer is meant as a drop-in upgrade for existing doorbell systems, to solve power-related issues.



WARNING: Risk of electrical shock
This manual is for educational purposes only. Working with electricity can be dangerous unless proper safety precautions

are taken. If you are not comfortable with the processes and tools described in this manual, we recommend that you hire a qualified electrician.

What's in the Box?

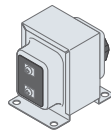

Doorbell Transformer
Use to convert household power to the voltage required for your Ring Video Doorbell Pro and internal doorbell chime.



Wire Nuts
Use to secure household power wires to the new transformer.



Mounting Screws
Use to mount your transformer, if you're not attaching it to a junction box.

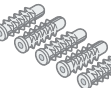

Wall Anchors
Use when mounting to a hard surface such as brick or concrete.

Shut off Power at the Breaker

You'll be working with electrical wires, so before you begin, turn off the circuit breaker that supplies power to your doorbell transformer.

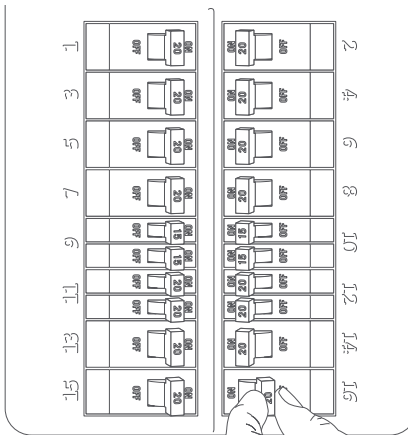

Locate your Existing Doorbell Transformer

In many houses, the doorbell transformer is installed in a junction box behind the internal doorbell chime, or mounted near other electrical components in a basement or crawl space.

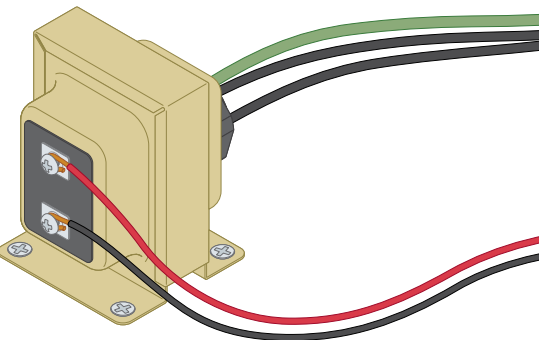

Remove your Existing Doorbell Transformer

Once power is shut off, you can remove your existing doorbell transformer. First, disconnect the three wires that connect the transformer to household power, then disconnect the two wires that are screwed into the terminals.

Note the position of each wire as you detach it. You may find it helpful to take a picture of the current install, for later reference.

Once all of the wires are detached, remove the transformer.

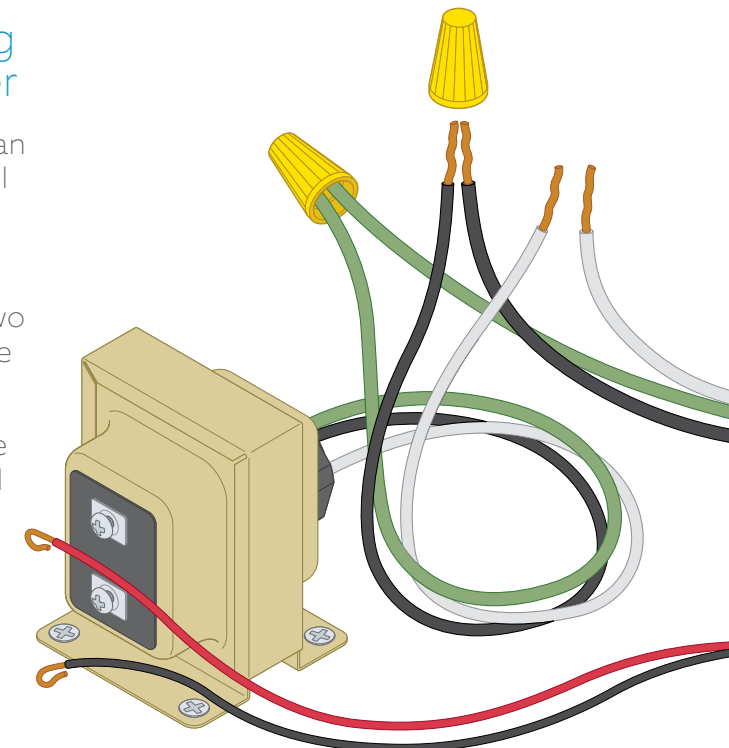

Mount Your New Doorbell Transformer

Securely mount the new transformer in place of the old transformer.

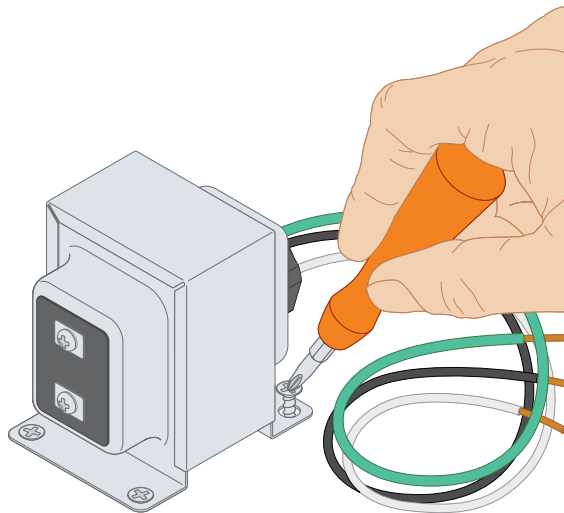

Connect the Wires

Once the new transformer is mounted, attach your household power wires to the matching wires on the new transformer, using the supplied wire nuts.

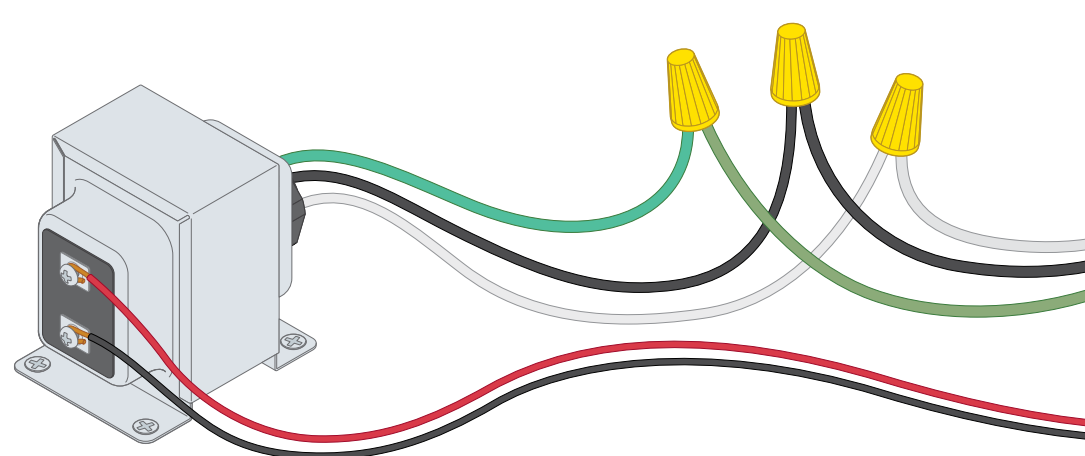

Then, connect your existing doorbell wires to the two screw terminals. It doesn't matter which wire goes to which terminal.

Note: This transformer is only for use with both a Ring Video Doorbell Pro and a 16-24 volt AC doorbell chime. To power a Ring Pro on its own, try the Ring Plug-in Adapter.

Restore Power at the Breaker

Now that the new transformer is mounted and wired, it's time to turn power back on and set up your Ring Video Doorbell Pro.

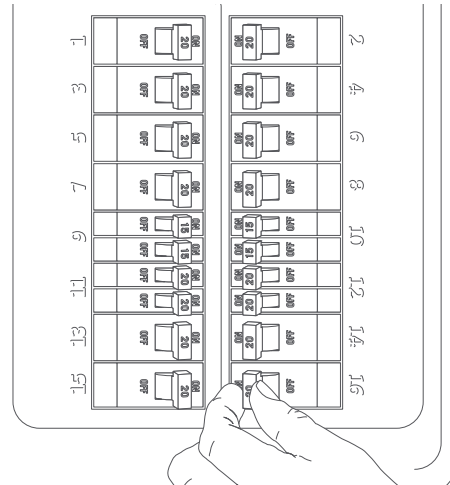

Set up your Ring Doorbell

If you haven't already, install your Ring Video Doorbell Pro, following the directions in the included user guide. Once you've finished, press the button on the front. If you hear a chime and get an Alert in the Ring app, that's a great sign!

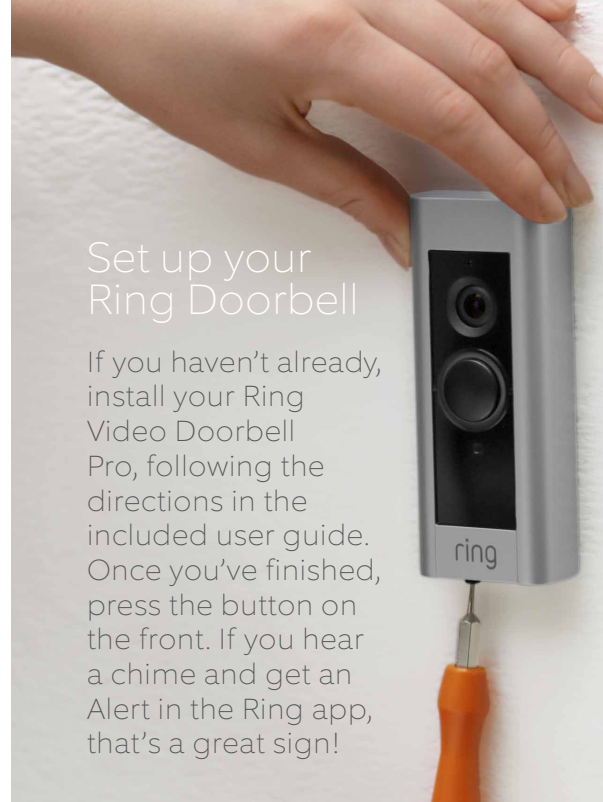

Check the Voltage

In the Ring app, tap your Ring Video Doorbell Pro, then tap Device Health. Check the Voltage reading—if it shows as “Good” or “Very Good,” you're ready to go.

If not, please step through the transformer and doorbell install instructions again to ensure that no steps were missed.

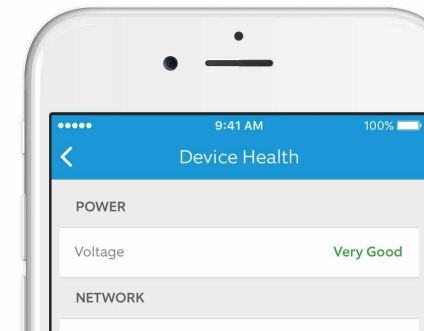

For additional help, visit: ring.com/help

Or give us a call...

[US 1 800 656 1918](tel:18006561918)

[Canada 1 855 300 7289](tel:18553007289)

[Mexico \(D.F\) 52 55 8526 5445](tel:525585265445)

[Worldwide +1 310 929 7085](tel:+13109297085)

For a list of all our customer support numbers, visit: ring.com/callus