

# ring

Video Doorbell



shown in Satin Nickel

## Getting Started

## Download the Ring App

The Ring app walks you through setting up and managing your Ring Video Doorbell.

The Ring app is available for iPhone, iPad, and Android.



Search for “Ring” in one of the app stores above, or visit [ring.com/app](http://ring.com/app)

## Grab your Wi-Fi password

It's required for the in-app setup. Write it down below so it's handy when you need it:

Your Wi-Fi password 

## Say Hello to the Back of your Ring Doorbell

**Setup Button** – You'll be instructed to push this during in-app setup.

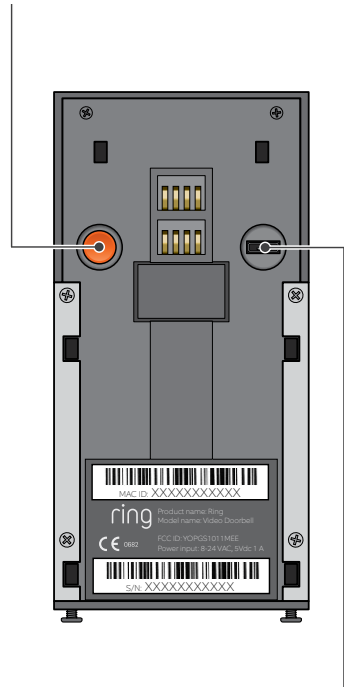

**Charging Port** – Plug the included USB cable in here to charge your Ring Doorbell, when needed.

## Follow the Steps in the Ring App

If you haven't already, open the Ring app and select Create Account. Once you're logged in, tap Set Up a Device to begin the setup process.

When prompted, select Doorbells and follow the in-app instructions.



## Push the Front Button to Test your Ring Doorbell

After setup, push the front button on your Ring Doorbell indoors to see video from your Ring in the Ring app.

Smile, you're on camera!

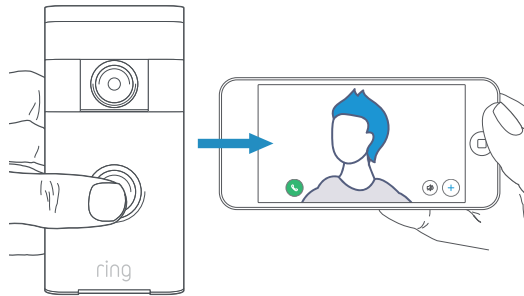

 If you have problems with video quality after installation, you may need to move your router closer to your door, or add a Ring Chime Pro. Learn more at: [ring.com/chime-pro](https://ring.com/chime-pro)

## Select an Install Location

For optimal performance, install your Ring Doorbell four feet above the ground.

If you're connecting to existing doorbell wiring that's higher than four feet, and want to angle your Ring for a better view, you can purchase a Wedge Kit at:

[ring.com/accessories](https://ring.com/accessories)

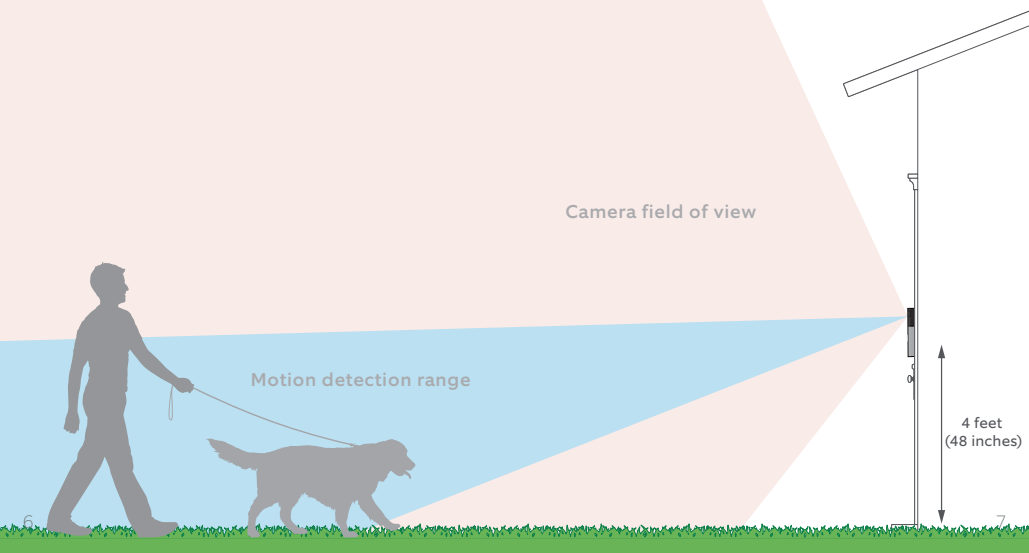

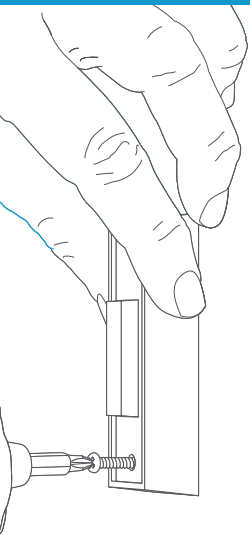

## Remove your Existing Doorbell

If you're connecting your Ring to existing doorbell wiring, first shut off power at the breaker.

Then remove your existing doorbell from the wall and disconnect the wires.

**i** If you notice a diode when you remove your wired doorbell, this means you will need to install the included diode with your Ring.



Diode

## Mark the Screw Holes

Snap the little orange level onto the mounting bracket, and use the bracket to mark the four corner holes.

The recommended install height is 4 feet above the ground.

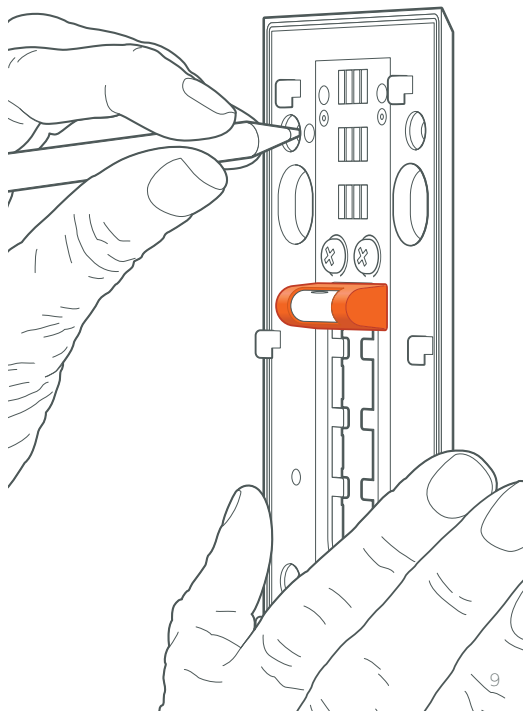

## Install the Anchors (optional)

On stucco, brick, or concrete, use the provided bit to drill holes in your wall, then insert the anchors.

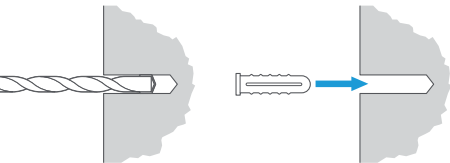
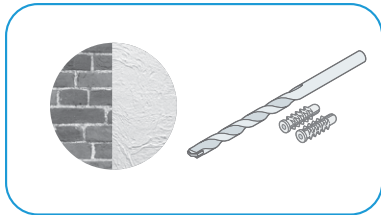

If you're installing on wood or siding, put the anchors in that drawer of stuff you never use and skip this step.

## Install the Mounting Bracket

Use the phillips head side of the Ring screwdriver to screw in the mounting bracket.

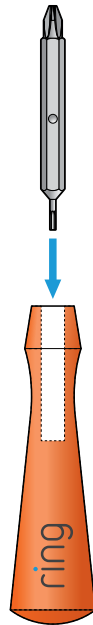

**i** Keep the orange screwdriver handy. You'll need it to take your Ring off the wall for charging.

## Installing the Mounting Bracket (continued)

Drive the screws into your wall (or into the anchors, if installed) until they are flush with the mounting bracket, and the bracket is flat against your wall.

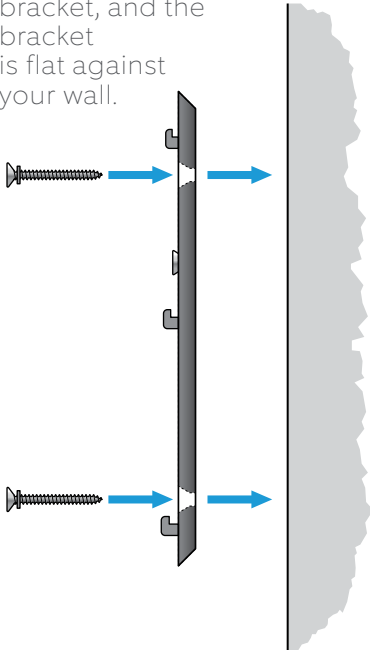

**i** If your wall is not completely flat, be careful not to screw the bracket in so tightly that it bends or bows.

## Connect the Wires (optional)

Connect your doorbell wires to the screws on the bracket.

It doesn't matter which wire connects to which screw.

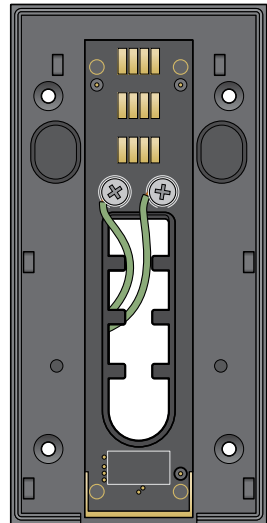

**i** The wiring must be connected to a transformer with a voltage of 8VAC – 24VAC and an internal doorbell or resistor.

DC transformers and most intercoms are not supported.

## How and When to Use the Diode

If your doorbell is digital (plays an electronic melody), attach the diode to the two screws on your bracket.

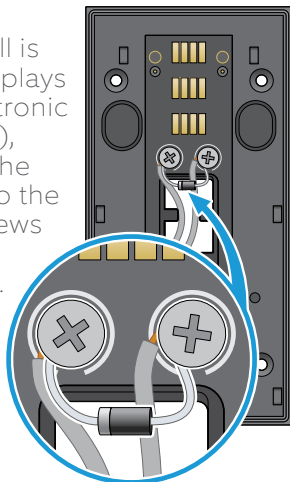

Put the gray indicator on the same side as the wire that leads to your internal doorbell.

If your doorbell is mechanical (makes a “ding-dong” sound), DO NOT INSTALL THE DIODE.

**i** If you have a digital doorbell, connecting the diode the wrong way won't do any harm. If your doorbell doesn't ring, just reverse the diode.

## Attach your Ring Doorbell to the Bracket

Line up the holes in your Ring Doorbell with the slots on the bracket.

Press firmly towards the wall and then down until you feel a click.

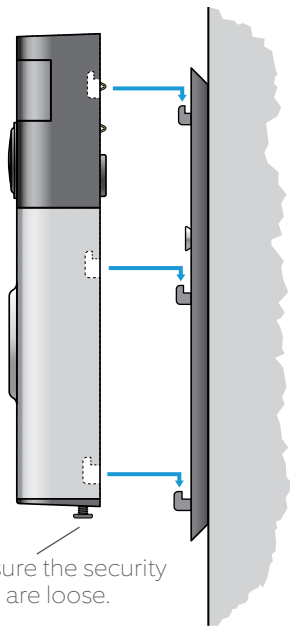

Make sure the security screws are loose.



## Secure your Ring Doorbell

Use the star-shaped end of your Ring screwdriver to tighten the security screws on the bottom of your Ring Doorbell.

If you wired in your Ring, now you can restore power at the breaker.

Congratulations, you're done!

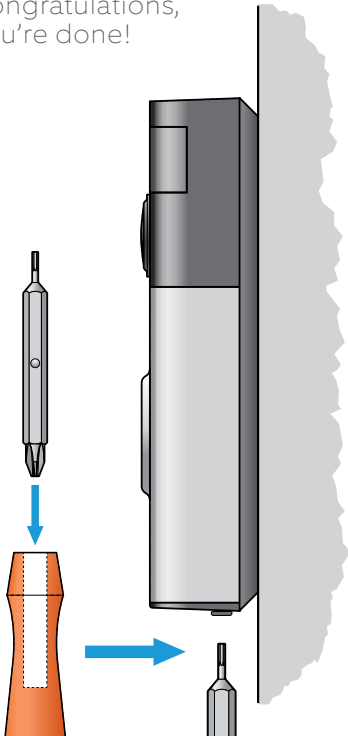

## Sign Up for Ring Protect

Your Ring Doorbell includes 30 free days of Ring Protect, a subscription service that stores video of each event your Ring products capture.



This lets you review Ring videos at your leisure and share them with anyone.

To keep your subscription active and save your videos, visit: [ring.com/recording](https://ring.com/recording)

Log into your Ring account, choose a **Ring Protect Plan**, and follow the on-screen instructions to subscribe.

# Need a little setup help?

## Get your Wi-Fi password just right.

The most common setup issues come from entering the wrong Wi-Fi password. These passwords are case-sensitive, and every little error counts.

## Reboot your router.

If you know you entered the right password but you're having no luck, try turning your Wi-Fi router off, wait 30 seconds, then turn it back on.

Then, start setup again in the Ring app.

## Start setup inside.

If you tried the tips above and setup still won't work, try moving your Ring Doorbell inside, near your Wi-Fi router. Then, start setup once more.

Once setup completes successfully, you can install your Ring at your door.



### BATTERY SAFETY

Use Ring-branded Quick-Release Battery Packs only. Do not dispose of batteries in fire. Batteries should be recycled or disposed of as per state and local guidelines. Do not open, disassemble, puncture, cut, bend, shred or heat the battery. Do not begin to leak, take steps to prevent the fluid from coming into direct contact with skin or clothes as the fluid could be corrosive and may be toxic. Protect the device from direct sunlight, install the device at dry locations and protect it against rain and humidity. The device should not be in contact with salt water or other conductive liquids. The device must be charged only within a building in a dry state. Small parts may pose choking hazards. Keep device and box contents out of reach of children. Use of the product is subject to your registration with Ring and your agreement with the Terms of Service found at [www.ring.com/terms](http://www.ring.com/terms)

**Operating temperature: -5°F to 120°F (-20.5°C to 48.5°C)**

### LIMITED WARRANTY AND THEFT PROTECTION FOR AUSTRALIA CONSUMERS

Our goods come with guarantees that cannot be excluded under the Australian Consumer Law. You are entitled to a replacement or refund for a major failure and compensation for any other reasonably foreseeable loss or damage. You are also entitled to have the goods repaired or replaced if the goods fail to be of acceptable quality and the failure does not amount to a major failure. Goods presented for repair may be replaced by refurbished goods of the same type rather than being repaired. Refurbished parts may be used to repair the goods.

#### 1. LIMITED WARRANTY

This is a "Limited Warranty" which gives you specific legal rights. You may also have other rights, which vary from jurisdiction to jurisdiction. Some jurisdictions, such as Australia, do not allow the exclusion or limitation of incidental or consequential damages, so the limitation or exclusion under this Limited Warranty may not apply to you. Please keep your dated sales receipt. It is required for all warranty claims. If you are otherwise provided by the Australian Consumer Law, any dispute or controversy regarding this Limited Warranty arising from your use of your Ring products will be resolved by final and binding arbitration in accordance with the "Dispute Resolution" section of the Terms of Service, found here.

#### 1. WHAT THE WARRANTY COVERS

For a period of one (1) year from the date of purchase of your Ring product, or one (1) year from the date of receipt of your replacement Ring product (see Section II below for details), Ring LLC ("Ring") will, at its sole option, repair or replace any Ring product that malfunctions due to defective parts or workmanship at no charge to you. This warranty is not transferable and applies only to the original consumer purchaser. Ring may, in its sole discretion, make any repair or replacement with new or refurbished product or components. If the product or component requiring repair or replacement is no longer available, Ring may, in its sole discretion, replace such product with a similar product of similar function.

#### 2. WHAT THE WARRANTY DOES NOT COVER

Repair service, damage due to misuse, abuse, negligence or casualty (e.g., fire), acts of God (including but not limited to lightning, flood, tornado, earthquake, or hurricane), and consumable parts (including batteries) are not covered by this warranty. Damage from unauthorized service or modification of the product or of any furnished component will void this warranty in its entirety. This warranty does not include reimbursement for inconvenience, installation, loss of use, or unavailability. In addition, this warranty does not cover any losses, injuries to persons, loss of property or general damages. This warranty, our theft protection, and community support services do not apply to any products purchased from third party sellers on eBay and other online marketplaces. We strongly suggest that you do not buy Ring products from any unauthorized sellers, as such products may be used, defaced or tampered with. They may not be designed for use in your country. This warranty covers only Ring products and is not extended to other equipment, components, or devices that a customer uses in conjunction with our products. Except in relation to any guarantees you may be entitled to under the Australian Consumer Law, Ring's maximum liability under this warranty is limited to the original purchase price of the Ring product in question. **THIS WARRANTY IS EXPRESSLY IN LIEU OF ALL OTHER WARRANTIES, (EXCEPT THOSE GUARANTEES YOU MAY BE ENTITLED TO UNDER THE AUSTRALIAN CONSUMER LAW), EXPRESSED OR IMPLIED, (INCLUDING ANY WARRANTY, REPRESENTATION OR CONDITION OF MERCHANTABILITY OR THAT THE PRODUCTS ARE FIT FOR ANY PARTICULAR PURPOSE OR USE, AND SPECIALLY IN LIEU OF ALL SPECIFIC WARRANTIES) AND DOES NOT COVER CONSEQUENTIAL DAMAGES. IF RING LLC CANNOT LAWFULLY DISCLAIM STATUTORY OR IMPLIED WARRANTIES, THEN TO THE EXTENT PERMITTED BY LAW AND EXCEPT IN RELATION TO ANY GUARANTEE YOU MAY BE ENTITLED TO UNDER THE AUSTRALIAN CONSUMER LAW, ALL SUCH WARRANTIES SHALL BE LIMITED IN DURATION TO THE DURATION OF THIS EXPRESS LIMITED WARRANTY AND TO REPAIR OR REPLACEMENT SERVICE. SOME JURISDICTIONS DO NOT ALLOW LIMITATIONS ON HOW LONG A STATUTORY OR IMPLIED WARRANTY LASTS, SO THE ABOVE LIMITATIONS MAY NOT APPLY TO YOU EXCEPT AS OTHERWISE PROVIDED BY THE AUSTRALIAN CONSUMER LAW. REPAIR OR REPLACEMENT SHALL BE THE SOLE REMEDY OF THE CUSTOMER AND THERE SHALL BE NO LIABILITY ON THE PART OF RING LLC FOR ANY SPECIAL, INCIDENTAL, CONSEQUENTIAL OR CONSEQUENTIAL DAMAGES, INCLUDING BUT NOT LIMITED TO ANY LOSS OF BUSINESS OR PROFITS, WHETHER OR NOT FORESEEABLE. SOME JURISDICTIONS, SUCH AS THOSE IN WHICH YOU ARE A RESIDENT, CONSUMER LAW APPLIES, DO NOT ALLOW THE EXCLUSION OR LIMITATION OF INCIDENTAL OR CONSEQUENTIAL DAMAGES, SO THE ABOVE LIMITATION AND EXCLUSIONS MAY NOT APPLY TO YOU.**

This limited warranty gives you specific rights. You may have additional rights under applicable law, and this limited warranty does not affect such rights.

## II. THEFT PROTECTION

If your Ring camera or doorbell product is stolen at any time after your purchase, Ring will replace the stolen device at no charge to you. This theft protection is not transferable and applies only to the original consumer purchaser. Coverage of this theft protection is limited to one (1) replacement only for each Ring camera or doorbell product that you have purchased. Theft protection does not apply to any products purchased from third party sellers on eBay and other online marketplaces. Any claim based on theft of your Ring camera or doorbell product must be submitted within fifteen (15) days of the theft and include the original sales receipt, and a copy of a police report evidencing that you reported the theft to the police. Failure to report the theft to police voids this theft protection.

### III. How to obtain service / replacement

To obtain the benefit of the above limited warranty or theft protection, please contact Ring community support at: [help@ring.com](mailto:help@ring.com)

+61 2 8294 9169

1300 205 983 (Toll Free)

For warranty requests where the Australian Consumer Law does not apply: Please be prepared to describe the product that needs service, the nature of the problem and to provide proof of purchase. You will also be required to return your existing device in accordance with directions that will be provided by Ring. Ring has no warranty obligations with respect to any products that are excluded from warranty pursuant to Paragraph 2 above, as reasonably determined by Ring, and the owner of such device shall bear all shipping costs for the return of such product to owner. Any claim under this Limited Warranty must be submitted to Ring before the end of the warranty period described above. Please allow up to fourteen (14) business days for your warranty request to be processed. For replacement requests: Please be prepared to describe the product that needs to be replaced and a copy of the police report. Please allow up to fourteen (14) business days for your replacement to be processed.

For additional help, visit: [ring.com/help](http://ring.com/help)

Or give us a call...

[AU 1 300 205 983](tel:+61282949169)

[NZ +64 9 887 9871](tel:+6498879871)

[Worldwide +1 310 929 7085](tel:+13109297085)

For a list of all our customer support numbers, visit:  
[ring.com/callus](http://ring.com/callus)



1523 26th St.  
Santa Monica, CA  
90404



© 2019 Ring LLC or its affiliates.

Ring, Alexa, Always Home, and all related logos are trademarks of Amazon.com, Inc. or its affiliates.

Last updated: 04/10/19