

ring

Video Doorbell



shown in Satin Nickel

Getting Started

Download the Ring App

The Ring app walks you through setting up and managing your Ring Video Doorbell.

The Ring app is available for iPhone, iPad, and Android.



Search for “Ring” in one of the app stores above, or visit ring.com/app

Grab your Wi-Fi password

It's required for the in-app setup. Write it down below so it's handy when you need it:

Your Wi-Fi password 

Say Hello to the Back of your Ring Doorbell

Setup Button – You'll be instructed to push this during in-app setup.

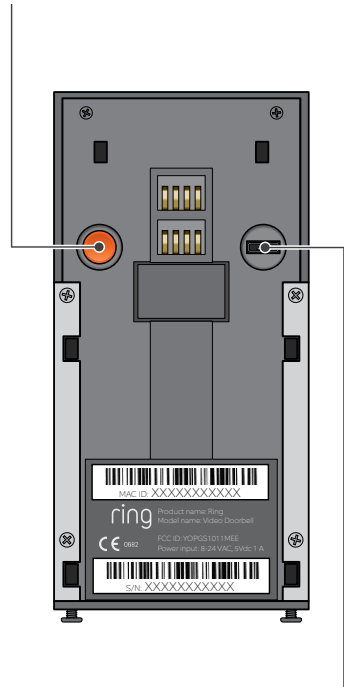

Charging Port – Plug the included USB cable in here to charge your Ring Doorbell, when needed.

Follow the Steps in the Ring App

If you haven't already, open the Ring app and select Create Account. Once you're logged in, tap Set Up a Device to begin the setup process.

When prompted, select Doorbells and follow the in-app instructions.



Push the Front Button to Test your Ring Doorbell

After setup, push the front button indoors to see video from your Ring in the Ring app.

Smile, you're on camera!

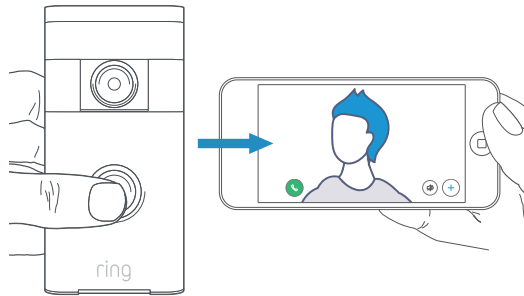

 If you have problems with video quality after installation, you may need to move your router closer to your door, or add a Ring Chime Pro. Learn more at: ring.com/chime-pro

Select an Install Location

For optimal performance, install your Ring Doorbell four feet above the ground.

If you're connecting to existing doorbell wiring that's higher than four feet, and want to angle your Ring for a better view, you can purchase a Wedge Kit at:

ring.com/accessories

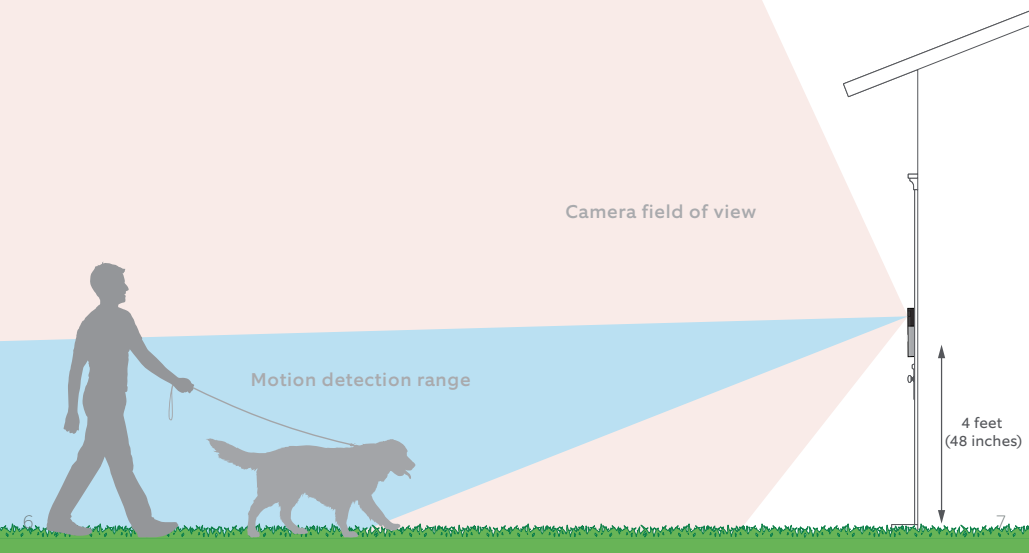

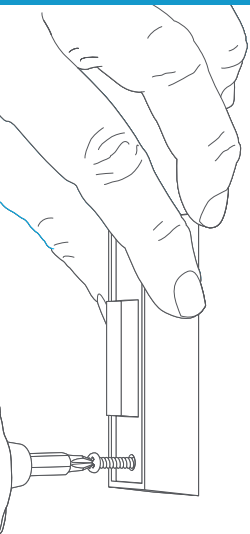

Remove your Existing Doorbell

If you're connecting your Ring to existing doorbell wiring, first shut off power at the breaker.

Then remove your existing doorbell from the wall and disconnect the wires.

i If you notice a diode when you remove your wired doorbell, this means you will need to install the included diode with your Ring.



Diode

Mark the Screw Holes

Snap the little orange level onto the mounting bracket, and use the bracket to mark the four corner holes.

The recommended install height is 4 feet above the ground.

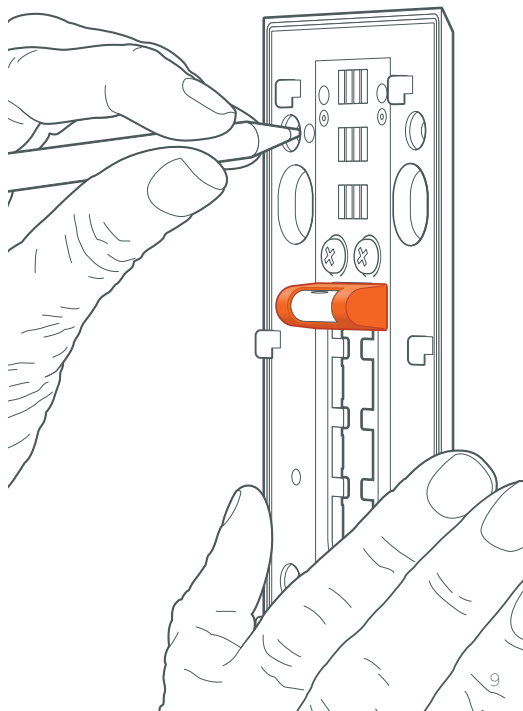

Install the Anchors (optional)

On stucco, brick, or concrete, use the provided bit to drill holes in your wall, then insert the anchors.

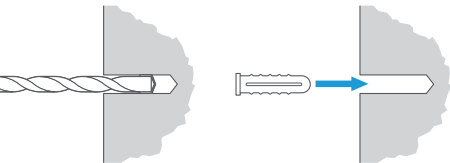
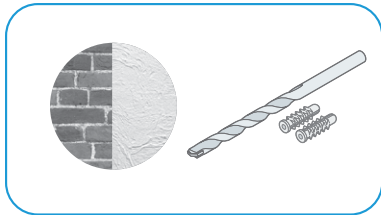

If you're installing on wood or siding, put the anchors in that drawer of stuff you never use and skip this step.

Install the Mounting Bracket

Use the phillips head side of the Ring screwdriver to screw in the mounting bracket.

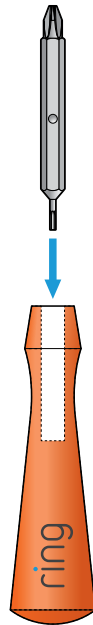

i Keep the orange screwdriver handy. You'll need it to take your Ring off the wall for charging.

Installing the Mounting Bracket (continued)

Drive the screws into your wall (or into the anchors, if installed) until they are flush with the mounting bracket, and the bracket is flat against your wall.

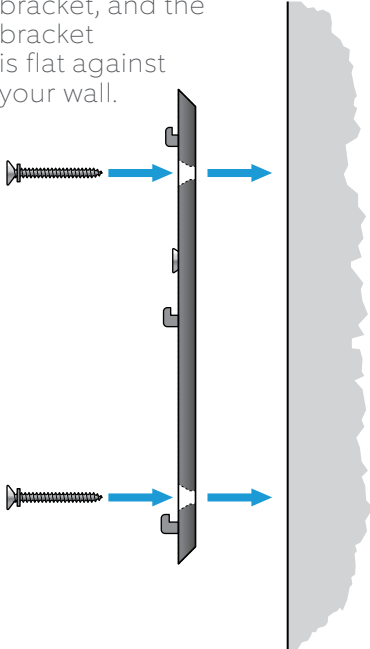

i If your wall is not completely flat, be careful not to screw the bracket in so tightly that it bends or bows.

Connect the Wires (optional)

Connect your doorbell wires to the screws on the bracket.

It doesn't matter which wire connects to which screw.

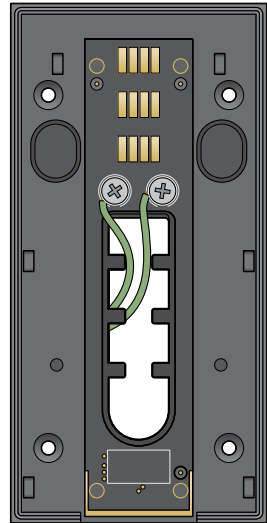

i The wiring must be connected to a transformer with a voltage of 8VAC – 24VAC and an internal doorbell or resistor.

DC transformers and most intercoms are not supported.

How and When to Use the Diode

If your doorbell is digital (plays an electronic melody), attach the diode to the two screws on your bracket.

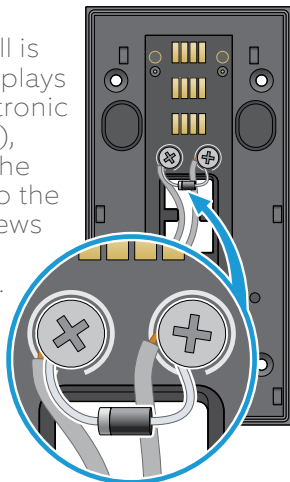

Put the gray indicator on the same side as the wire that leads to your internal doorbell.

If your doorbell is mechanical (makes a “ding-dong” sound), DO NOT INSTALL THE DIODE.

i If you have a digital doorbell, connecting the diode the wrong way won't do any harm. If your doorbell doesn't ring, just reverse the diode.

Attach your Ring Doorbell to the Bracket

Line up the holes in your Ring Doorbell with the slots on the bracket.

Press firmly towards the wall and then down until you feel a click.

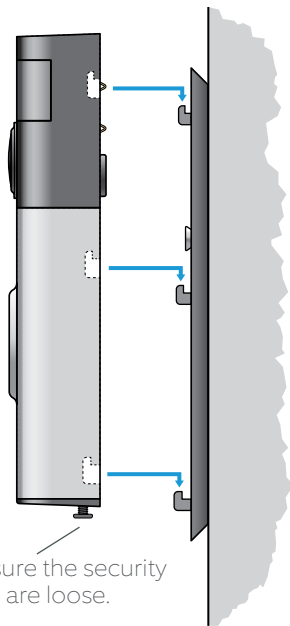

Make sure the security screws are loose.

Secure your Ring Doorbell

Use the star-shaped end of your Ring screwdriver to tighten the security screws on the bottom of your Ring Doorbell.

If you wired in your Ring, now you can restore power at the breaker.

Congratulations, you're done!

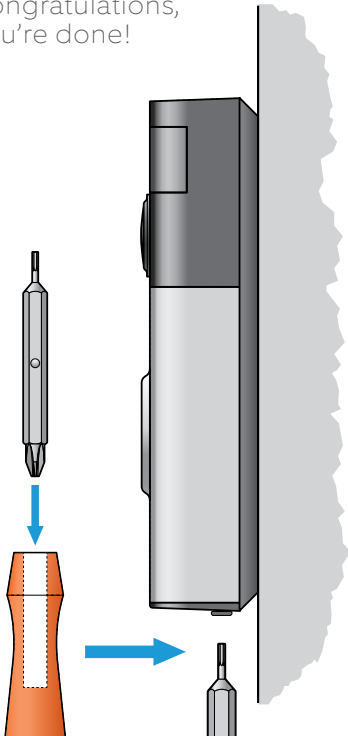

Sign Up for Ring Protect

Your Ring Doorbell includes 30 free days of Ring Protect, a subscription service that stores video of each event your Ring products capture.

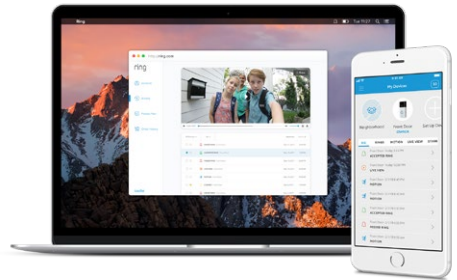

This lets you review Ring videos at your leisure and share them with anyone.

To keep your subscription active and save your videos, visit: ring.com/recording

Log into your Ring account, choose a **Ring Protect Plan**, and follow the on-screen instructions to subscribe.

Need a little setup help?

If your in-app setup doesn't go as planned, try out these tips:

Get your Wi-Fi password just right.

The most common setup issues come from entering the wrong Wi-Fi password. These passwords are case-sensitive, and every little error counts.

So grab your password and write it here, so you'll know just what to enter:

Reboot your router.

If you know you entered the right password but you're having no luck, try turning your Wi-Fi router off, wait 30 seconds, then turn it back on.

Then, start setup again in the Ring app.

Start setup inside.

If you tried the tips above and setup still won't work, try moving your Ring Doorbell inside, near your Wi-Fi router. Then, start setup once more.

Once setup completes successfully, you can install your Ring at your door.

Need additional help?

If the problem you're having isn't addressed here, and you need further help, scan the code below with the camera app on your iPhone or a QR code scanning app on your Android device.



For additional help, visit: ring.com/help

Or give us a call...

[US 1 800 656 1918](tel:18006561918)

[Canada 1 855 300 7289](tel:18553007289)

[Worldwide +1 310 929 7085](tel:+13109297085)

For a list of all our customer support numbers, visit:
ring.com/callus

 1523 26th St.
Santa Monica, CA
90404

This device complies with Part 15 of the FCC Rules. Operation is subject to the following two conditions: (1) this device may not cause harmful interference, and (2) this device must accept any interference received, including interference that may cause undesired operation.

Use Ring-branded Quick-Release Battery Packs only. Do not dispose of batteries in fire. Batteries should be recycled or disposed of as per state and local guidelines.

Warning: Changes or modifications to this unit not expressly approved by the party responsible for compliance could void the user's authority to operate the equipment.

NOTE: This equipment has been tested and found to comply with the limits for a Class B digital device, pursuant to Part 15 of the FCC Rules. These limits are designed to provide reasonable protection against harmful interference in a residential installation. This equipment generates, uses and can radiate radio frequency energy and, if not installed and used in accordance with the instructions, may cause harmful interference to radio communications.

However, there is no guarantee that interference will not occur in a particular installation. If this equipment does cause harmful interference to radio or television reception, which can be determined by turning the equipment off and on, the user is encouraged to try to correct the interference by one or more of the following measures:

Reorient or relocate the receiving antenna.

Increase the separation between the equipment and receiver.

Connect the equipment into an outlet on a circuit different from that to which the receiver is connected.

Consult the dealer or an experienced radio/TV technician for help.

Hereby, Ring LLC declares that this consumer electronic is in compliance with the essential requirements and other relevant provisions of Directive 1999/5/EC. The declaration of conformity may be consulted at www.ring.com/DoC.pdf.

Protect the device from direct sunlight. Install the device at dry locations and protect it against rain and humidity. The device may not get contact to salt water or other conductive liquids. The device must be charged only within a building in a dry state.

 To review your warranty coverage, please visit www.ring.com/warranty.

Patents: www.ring.com/patents

© 2019 Ring LLC or its affiliates.

Ring, Alexa, Always Home, and all related logos are trademarks of Amazon.com, Inc. or its affiliates.

Last updated: 03/19/19